



## Thru-beam sensor ML29-P/25/103/115



- Single-beam monitoring with extremely narrow sensor
- Integrated circuit
- Test
- Simple installation - Plug & Play
- Ideal for installation in door profiles or frames
- Light on version

Single-beam miniature sensor, ideal for installing in frames or door profiles



### Function

The narrow miniature thru-beam sensors are a small and cost-effective solution, fitting in virtually any door frame. The ML29 and ML30 series offer fast, reliable detection at a distance of up to 8.5 m. The sensors are easy to mount on the profile, either using adhesive strips or a screw. A large opening angle ensures problem-free alignment. Several sensors can be mounted in a cross formation to offer multi-beam protection.

### Application

- Person detection for automatic doors and gates
- Closing edge protection on sliding and revolving doors
- Threshold monitoring for elevator doors
- Step monitoring for doors on public transport vehicles
- Trigger function for restarting escalators

## Dimensions

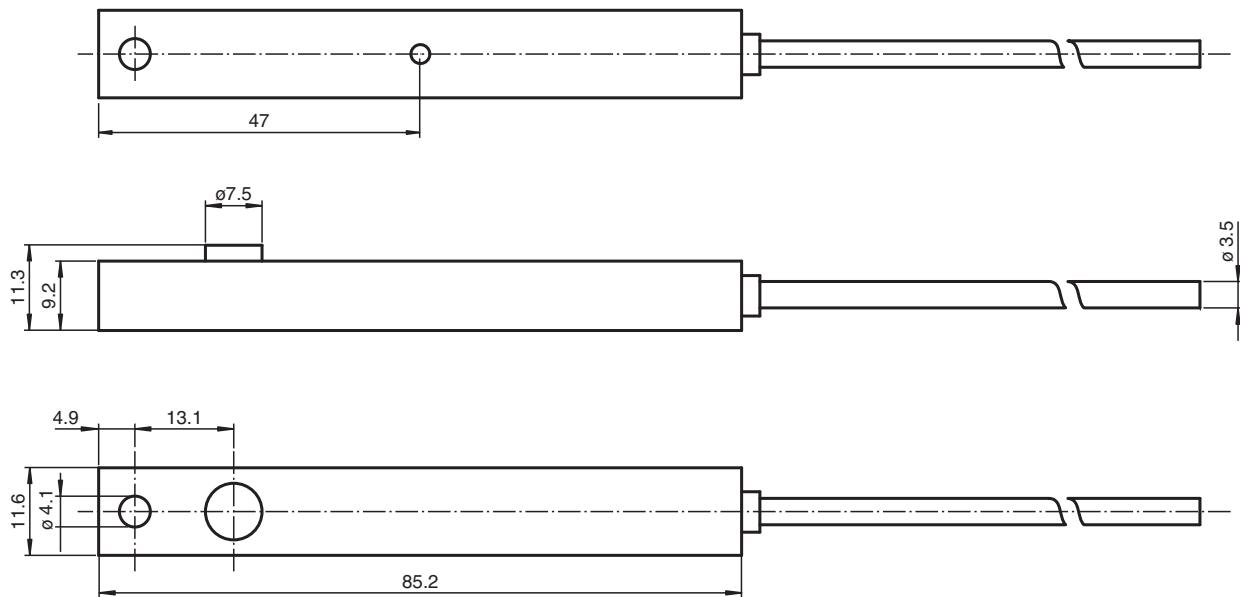

## Technical Data

System components		
Emitter		ML29-T/115
Receiver		ML29-R/25/103/115
General specifications		
Effective detection range		0 ... 6 m
Threshold detection range		8.5 m
Light source		IRED
Light type		modulated infrared light
Opening angle		+/- 8 °
Optical face		lateral
Ambient light limit		40000 Lux
Functional safety related parameters		
MTTF <sub>d</sub>		880 a
Mission Time (T <sub>M</sub> )		20 a
Diagnostic Coverage (DC)		0 %
Indicators/operating means		
Function indicator		LED red in receiver : lights up when receiving the light beam
Electrical specifications		
Operating voltage	U <sub>B</sub>	11 ... 30 V DC
No-load supply current	I <sub>0</sub>	Emitter: ≤ 25 mA Receiver: ≤ 10 mA
Input		

Release date: 2023-05-04 Date of issue: 2023-05-04 Filename: 129311\_eng.pdf

## Technical Data

Test input	Test: Transmitter switches off at +UB ≤ 5 V DC	
<b>Output</b>		
Switching type	light-on	
Signal output	1 PNP output, short-circuit protected, reverse polarity protected, open collector	
Switching voltage	max. 30 V DC	
Switching current	max. 0.1 A	
Switching frequency	f	100 Hz
Response time	5 ms	
<b>Conformity</b>		
Product standard	EN 60947-5-2	
<b>Compliance with standards and directives</b>		
Standard conformity		
Standards	EN 61000-6-2, EN 61000-6-3	
<b>Approvals and certificates</b>		
CCC approval	CCC approval / marking not required for products rated ≤36 V	
<b>Ambient conditions</b>		
Ambient temperature	-20 ... 60 °C (-4 ... 140 °F)	
Storage temperature	-20 ... 75 °C (-4 ... 167 °F)	
Relative humidity	90 % , noncondensing	
<b>Mechanical specifications</b>		
Degree of protection	IP65	
Connection	6 m fixed cable	
Material		
Housing	PMMA , black	
Optical face	Plastic pane	
Mass	per device 12 g	

## Connection Assignment

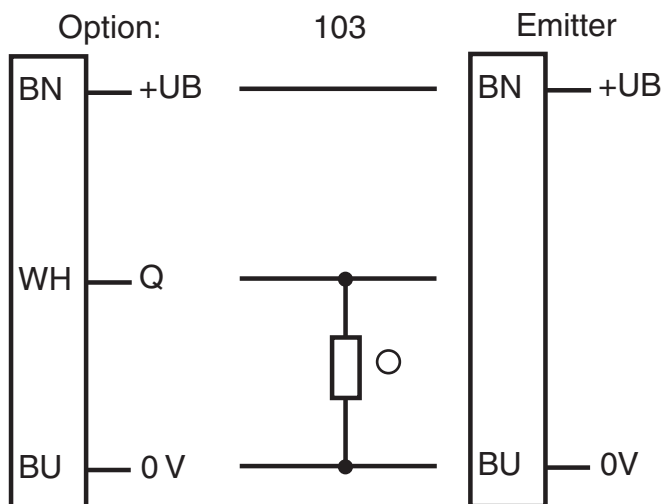

○ = Light on  
● = Dark on

**Assembly**

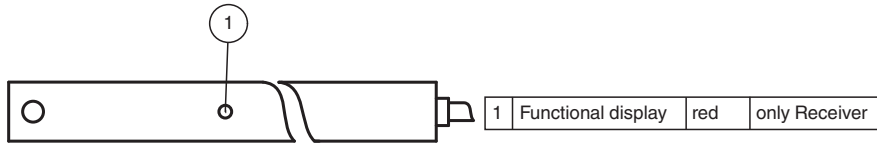

**Characteristic Curve**

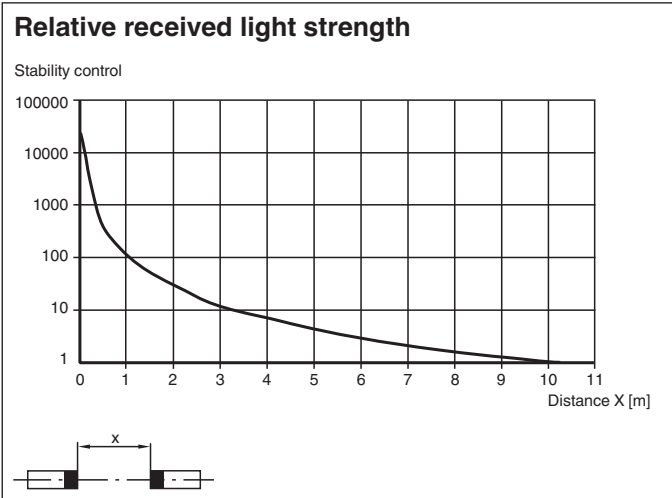
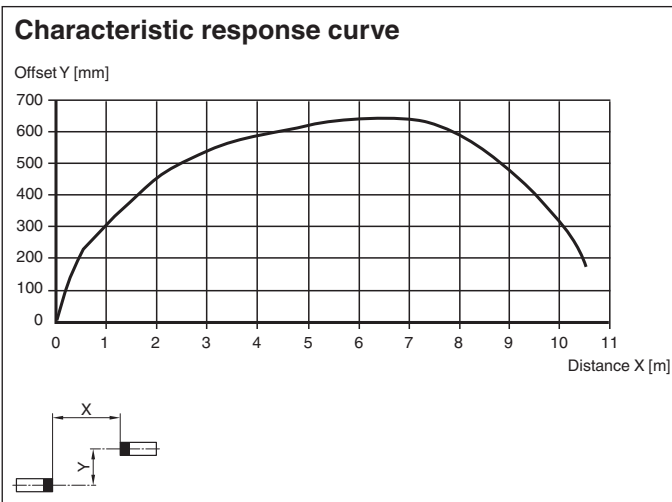

**Accessories**

	<b>ML29 Front Plate</b>	Front plate for thru-beam sensors in series ML29
---	-------------------------	--

Release date: 2023-05-04 Date of issue: 2023-05-04 Filename: 129311\_eng.pdf

**Additional Information**

**Static detection:**

The thru-beam sensor detects persons and objects independently of movement and surface structure for as long as the object breaks the detection beam.

		Electronic output
Light detection /25	Person in the beam	Inactive
	No person in the beam	Active
Dark detection /59	Person in the beam	Active
	No person in the beam	Inactive

**Optics:**

The relatively wide opening angles enable the light beam switches to be installed quickly, without alignment problems. Even if there is a light distortion of the installation profiles the function is retained.

**Testing:**

Testing is used to check the function of the light beam switch.

With supply voltage  $+U_B < 5 V$  the emitter device is switched off. This simulates a light beam interruption. By means of this, the function of the light barrier can be tested easily without using a separate test input.

**Installation:**

Thanks to its small dimensions, the light beam can be fitted in a U-profile or behind a face panel. The hole diameter for both the emitter and the receiver is 8 mm.

Even fixing by means of the adhesive tape contained in the delivery package can be considered.

**Installation of twin-beam arrangement:**

A twin-beam version requires 2 emitters and receivers. Care should be taken that the beam separation is not less than 20 cm. The transmitters and receivers must be arranged in the form of a cross.

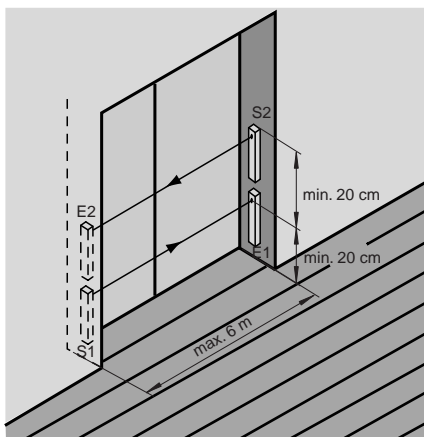

Release date: 2023-05-04 Date of issue: 2023-05-04 Filename: 129311\_eng.pdf

**Function Principle**

The thru-beam sensor requires a pair of devices for operation, comprising a light transmitter and a light receiver. The emitter and receiver must be arranged in optical alignment with each other. The infrared light from the emitter is detected by the receiver and evaluated.