

NIVOFLOAT NL/NW

FLOAT LEVEL SWITCHES FOR POTABLE WATER, SEWAGE



3 YEARS WARRANTY

NIVELCO

LEVEL SWITCHES

The NIVOFLOAT NL-100 float level switch is suitable for clean or slightly contaminated water. The NIVOFLOAT NW-100 tilting-float level switch is for sewage, tanks, basins, or cisterns. The waterproof dual-chambered float is injection-molded polypropylene, and the microswitch is incorporated into the float.

The cable is lead through a waterproof sealed entry point into the monolithic structure of the injection-molded plastic housing. It uses three copper wires of 1 mm² (AWG17) cross-section, insulated with PVC or Neoprene. The double-walled design provides outstanding safety for users in terms of life and touch protection. In addition, the NIVOFLOAT is suitable for various control tasks, such as liquid level monitoring and pump control. These devices serve reliably provided their operating conditions are appropriately selected.



NL-100

OPERATION

The NIVOFLOAT NL-100 type float level switch featuring mercury-free contact is suitable for level switching of drinking water, raw water or polluted liquids with low solid content. The double-chambered float and the sealing of the cable outlet provide hermetic sealing and water-proof operation.

The NIVOFLOAT NL-100 is floating on the level of the measured liquid because its relative density is less than the water. The level switching is done when the contact reaches the ±45° switching angle. The switching differential of the level switch is adjustable by the position of the counterweight on the cable. The level switches should be arranged appropriately in case of multi-level switching tasks to avoid undesired tangling of the cables.

FEATURES

- Dual-chambered float
- Switching differential is adjustable by counterweight
- Up to 20 m (66 feet) cable length
- Medium temperature up to +50 °C (+122 °F)
- Process pressure maximum 1 bar (14.5 psi)
- Variants for potable water available
- IP68

APPLICATIONS

- Potable water
- Industrial and communal sewage
- Tank filling/emptying control
- Overfill protection

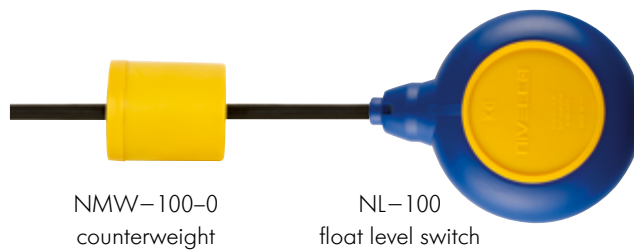

NMW-100-0
counterweight

NL-100
float level switch

TECHNICAL DATA

NL□-100-1	
Switching angle	±45°
Medium temperature	0...+50 °C (+32...+122 °F)
Process pressure	up to 1 bar (14.5 psi)
Material of the float	Polypropylene
Material of the counterweight	Polystyrene
Float volume	430 cm ³ (26.25 in ³)
Rating of the microswitch	10(4) A, 250 V AC, AC1
Electrical life-span	10 ⁷ switches
Ingress protection	IP68
Cable	Ø9 mm (0.35") / 3 × 1 mm ² (AWG17)
Cable length	5 m (196.8"), 10 m (393.7"), 20 m (787.4")
Weight (without cable)	250 g (0.55 lb)

DIMENSIONS

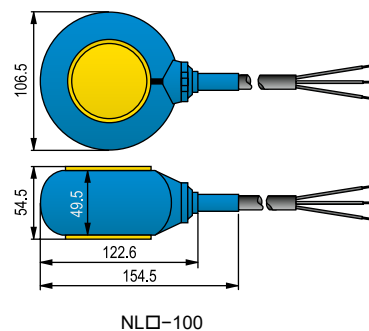

NL□-100

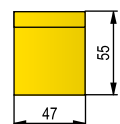

NMW-100-0

NW-100

OPERATION

The NIVOFLOAT NW-100 tilting level switch featuring mercury free contact is suitable for level switching of sewage, polluted liquids or drinking water. The double-chambered float and the sealing of the cable outlet provide hermetic sealing and water-proof operation.

The float should be immersed to the required level and fixed if needed. At the given level, the float will switch by tilting. The special shape of the float ensures proper tilting without using a counterweight.

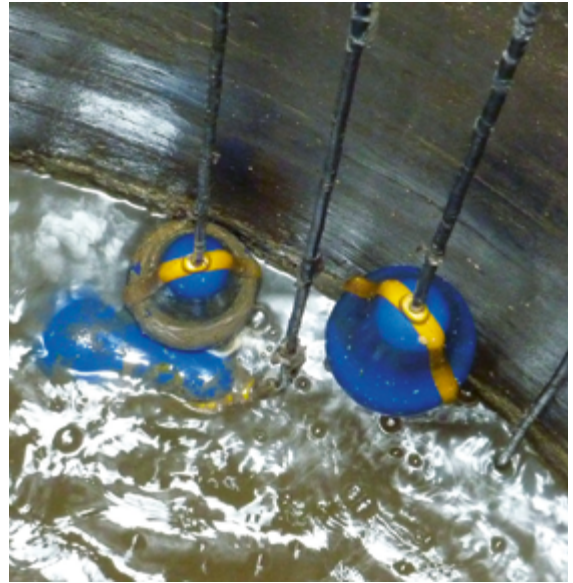

FEATURES

- Special float shape
- Dual-chambered float
- Up to 20 m (66 feet) cable length
- Medium temperature up to +50 °C (+122 °F)
- Process pressure maximum 2 bar (30 psi)
- Variants for potable water available
- IP68

APPLICATIONS

- Industrial and communal sewage
- Suitable for drinking water
- Tank filling/emptying control
- Overfill protection



NW-100
float level switch

TECHNICAL DATA

NW-100-1	
Switching differential	~400 mm (15.7") (constant)
Medium temperature	0...+50 °C (+32...+122 °F)
Process pressure	up to 2 bar (30 psi)
Material of the float	Polypropylene
Float volume	1000 cm ³ (61 in ³)
Rating of the microswitch	10(3) A, 250 V AC, AC1
Electrical life-span	10 ⁷ switches
Ingress protection	IP68
Cable	Ø9 mm (0.35") / 3 × 1 mm ² (AWG17)
Cable length	5 m (196.8"), 10 m (393.7"), 20 m (787.4")
Weight (without cable)	1.1 kg (2.4 lb)

DIMENSIONS

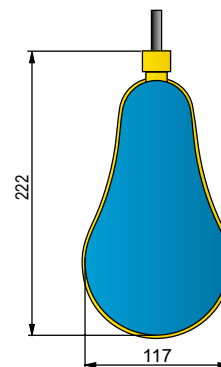

NW-100

nlmw1022.en01b

APPLICATION EXAMPLES

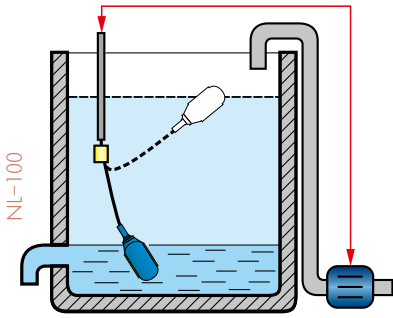

FILLING CONTROL

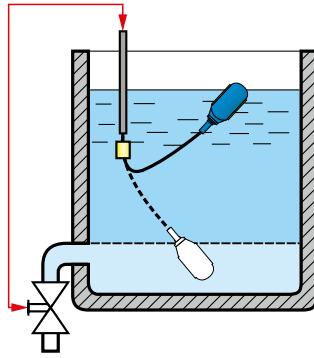

EMPTYING CONTROL

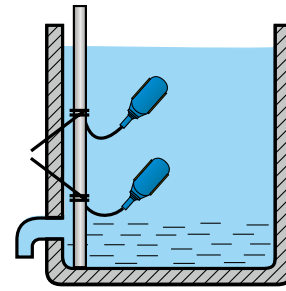

MULTI-LEVEL SWITCHING

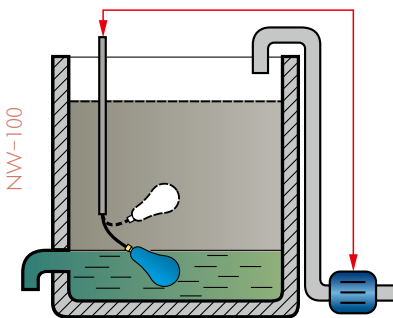

NW-100

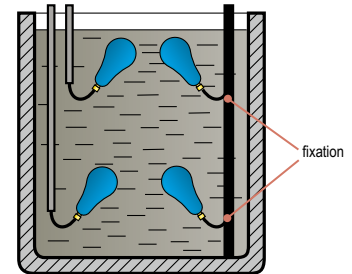
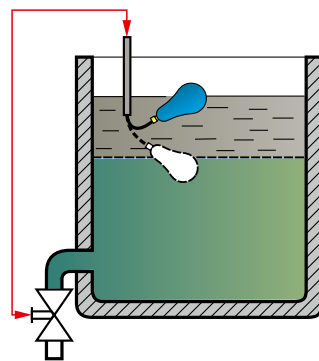

fixation

WIRING

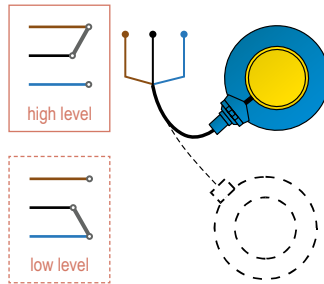
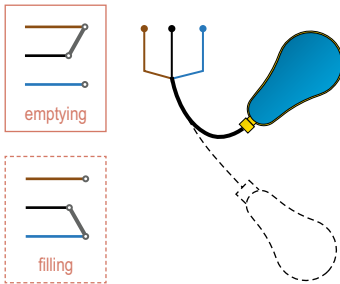

INSTALLATION

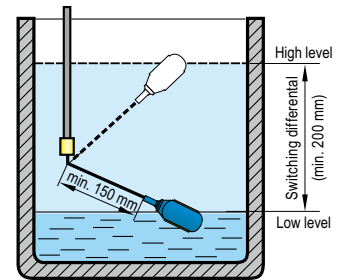

ORDER CODES (NOT ALL COMBINATIONS AVAILABLE)

NIVOFLOAT – dual-chambered float level switches

N ■ ■ -1 ■ ■ -1

Type	Code
For clean water	L
For waste water	W

Cable material	Code
Neoprene	N
PVC	P

Cable length	Code
5 m (196.8")	05
10 m (393.7")	10
20 m (787.4")	20

Without Counterweight*

*The NIVOFLOAT NMW-100-0 counterweight can be ordered separately

